



Bison IV Operating, LLC

518 17th Street, Suite 1800
Denver, CO 80202
Phone: 720-644-6997
Fax: 303-974-1767

RULE 304.e. SUBSTANTIALLY EQUIVALENT INFORMATION COVER SHEET

Dorado 36 Oil and Gas Development Plan

Dorado 36 Pad: SENW Section 36, Township 7 North, Range 63 West

Form 2A Doc #403716841

Weld County, Colorado

The attached 1041 WOGLA Application document is being submitted as a substantially equivalent document to the Light Mitigation Plan required by ECMC Rule 304.c.(3).

This document was developed for the Weld County 1041 WOGLA.

This document does not conform to ECMC rules or guidance in the following ways:

None.

This document should be accepted as substantially equivalent:

The attached Lighting Plan within the 1041 WOGLA Application 1041WOGLA24-0006 contains all of the substantially equivalent information required as an equivalent lighting plan document pursuant to Rule 304.c.(3) and Rule 424.a.



Weld County Oil and Gas Location Assessment
1041 WOGLA Permit Application

DORADO 36

LIGHTING PLAN



Bison IV Operating, LLC
Dorado 36 PAD LIGHTING PLAN

Contents

Article I. Introduction2
 Location Information2
Article II. Plan Narrative2
 Jurisdictional Agency.....2
Article III. Mitigation Measures and Best Management Practices3
Article IV. Exhibits/References/Appendices.....3



Article I. Introduction

Location Information

This document provides site-specific information for the Dorado 36 Pad within the Dorado 36 OGD. The information in this document relates specifically to the time during the construction, drilling, completion, interim reclamation, and production of the ten (10) proposed horizontal wells on this location.

The Dorado 36 Pad will utilize an existing access point approximately 0.80 miles east of the intersection of County Road 74 and County Road 74 on the north side of the road. The Dorado 36 Pad will be in the SENW of Section 36, Township 7 North, Range 63 West, and is located on parcel 071336000008 owned by the State of Colorado. The Dorado 36 Pad is zoned Agricultural within Weld County’s Ag-Rural planning area and is currently being used for livestock grazing. A 1041WOGLA is being filed with the OGD application as 1041WOGLA24-0006.

Construction of the proposed Location, with associated cut and fill slopes, would initially disturb approximately 16.6 acres. During the construction phase, the working pad surface (WPS) will be 9.2 acres. Following the interim reclamation of 4.1 acres, the total Dorado 36 Location residual surface disturbance will be reduced to approximately 12.5 acres. The total residual surface disturbance of 12.5 acres includes the production pad working surface, seeded topsoil pile, and seeded detention pond area. The long-term permanent disturbance area for the Production Facility will be 5.3 acres

The proposed production facility equipment for the Dorado 36 Pad will be located within the Working Pad Surface adjacent to the wells and will consist of oil tanks, produced water tanks, separators, a vapor recovery tower (VRT), oil polishers, gas lift compressors, vapor recovery units (VRU), oil and water LACTs, pigging stations, scrubbers, knockouts, a blower/oxygen destructor, instrument air skids, gas lift meters, sales gas meters, electrical skids, electrical generators, emission control devices (ECD), and a recycle pump.

Pending approval from Weld County and the ECMC, the project schedule is as follows:

Phase	Duration (days)	Estimated Start Date
Construction	+/- 30 days	3 rd Quarter 2025
Drilling	+/- 60 days	3 rd Quarter 2025
Completion	+/- 45 days	4 th Quarter 2025
Flowback	+/- 10 days	1 st Quarter 2026
Production	Ongoing +/- 30 years	1 st Quarter 2026
Interim Reclamation	+/- 30 days	2 nd Quarter 2026*

**or the first favorable weather/growing season.*

Article II. Plan Narrative

Jurisdictional Agency

The Relevant Local Government has lighting plan requirements under applicable Weld County code.

The Land Use designation of the proposed Location is agricultural within the Ag-Rural Planning Area. Bison, OGED, CPW, and ECMC OGLA staff confirmed in the pre-application meeting that a lighting plan for the Construction Phase is required to provide confirmation of the ability to comply within 12.0 lumens per square foot (SF) of hardscape, and a Lighting Plan for the Production Phase is required if permanent lighting is planned.



Bison is submitting a Photometric Plan with the 1041 WOGLA Application submittal adhering to Lighting Zone 0 of the Weld County Code Development Standards, Section 21-5-402.A.1, which allows up to 12.0 lumens per SF of hardscape during construction and up to 0.5 lumens per SF of hardscape during production. There will be permanent lighting onsite during the production phase emitting 0.34 lumens per SF.

Bison IV's consultants had completed the Lighting Plan for all phases of development on the Dorado 36 pad before Bison IV revised the design to include a full wrap sound wall for drilling and completions. According to Weld County Code, Section 21-5-402 an exemption may be granted for the Construction Phase lighting plan, if the Location includes thirty-two (32) foot sound walls on all sides. Since the Dorado 36 pad was shown to be compliant with the lighting standards before the sound walls were added, Bison did not update the plans to reflect the sound walls. Instead of requesting an exemption, Bison chose to keep the existing plans as they are, showing compliance.

The ECMC's Maximum Permissible Light Levels (Rule 424) are as follows:

Land Use	Lumens per SF of WPS
Residential/Rural/State Parks/State Wildlife Areas/High Priority Habitat/Wilderness Areas/National Park/National Monument	1.25
Commercial/Agricultural	2.5
Light Industrial	5.0
Industrial	7.5

The standards within ECMC Rule 424 are less protective than WOGLA standards. Bison will comply with the stricter agency's (Weld County) standards.

Article III. Mitigation Measures and Best Management Practices

- Bison will direct site lighting downward and inward, such that no light shines above a horizontal plane passing through the center point light source.
- Bison will use appropriate technology within fixtures that obscures, blocks, or diffuses the light to reduce light intensity outside the boundaries of the Dorado 36 Location.
- Bison will minimize lighting when not needed to minimize light pollution and obtrusive lighting.
- Bison will use full cut-off lighting to minimize light pollution and obtrusive lighting.
- Bison will use lighting colors that reduce light intensity to minimize light pollution and obtrusive lighting.
- Bison will use low-glare or no-glare lighting to minimize light pollution and obtrusive lighting.
- When Bison has active operations involving personnel ongoing the Location, Bison will provide sufficient on-site pre-production lighting to ensure the safety of all persons on or near the site.
- Bison will take all necessary and reasonable precautions to ensure that lighting from the Dorado 36 Oil and Gas Facilities does not unnecessarily impact the health, safety, and welfare of motorists on nearby roads.
- Bison's Contractor to install a lighting contactor and photocell to control all production lighting.

Article IV. Exhibits/References/Appendices

Please see attached signed Lighting Layout sheets and manufacturer's cut sheets.

THIS DRAWING AND THE DESIGN IT COVERS ARE CONFIDENTIAL AND REMAIN THE PROPERTY OF BISON IV OPERATING AND SHALL NOT BE DISCLOSED TO OTHERS OR REPRODUCED IN ANY MANNER OR USED FOR ANY PURPOSE WHATSOEVER EXCEPT BY WRITTEN PERMISSION BY THE OWNER.

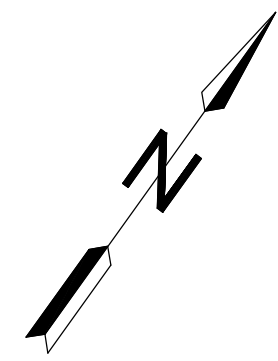

LIGHTING FIXTURE SCHEDULE								
TYPE	SYMBOL	DESCRIPTION	MOUNTING	MANUFACTURER	PART NUMBER	VOLTAGE	QTY.	LUMENS
L1		MOBILE LIGHT TOWER (4 LED LIGHTS MOUNTED PER TRAILER) (296W LED - EACH LIGHT)	23' MAST HEIGHT	GENERAC MAGNUM	MLT6SMDS (1000001 9145)	120/240VAC	4	172,200

SITE TOTALS - WELL COMPLETION	
TOTAL LUMENS	688,800 LUMENS
SITE DISTURBANCE SQUARE FOOTAGE	401,500 SQFT
LUMENS/SQ.FT	1.72 LUMENS/SQFT
ILLUMINATION AT 1-MILE	<0.1 LUX

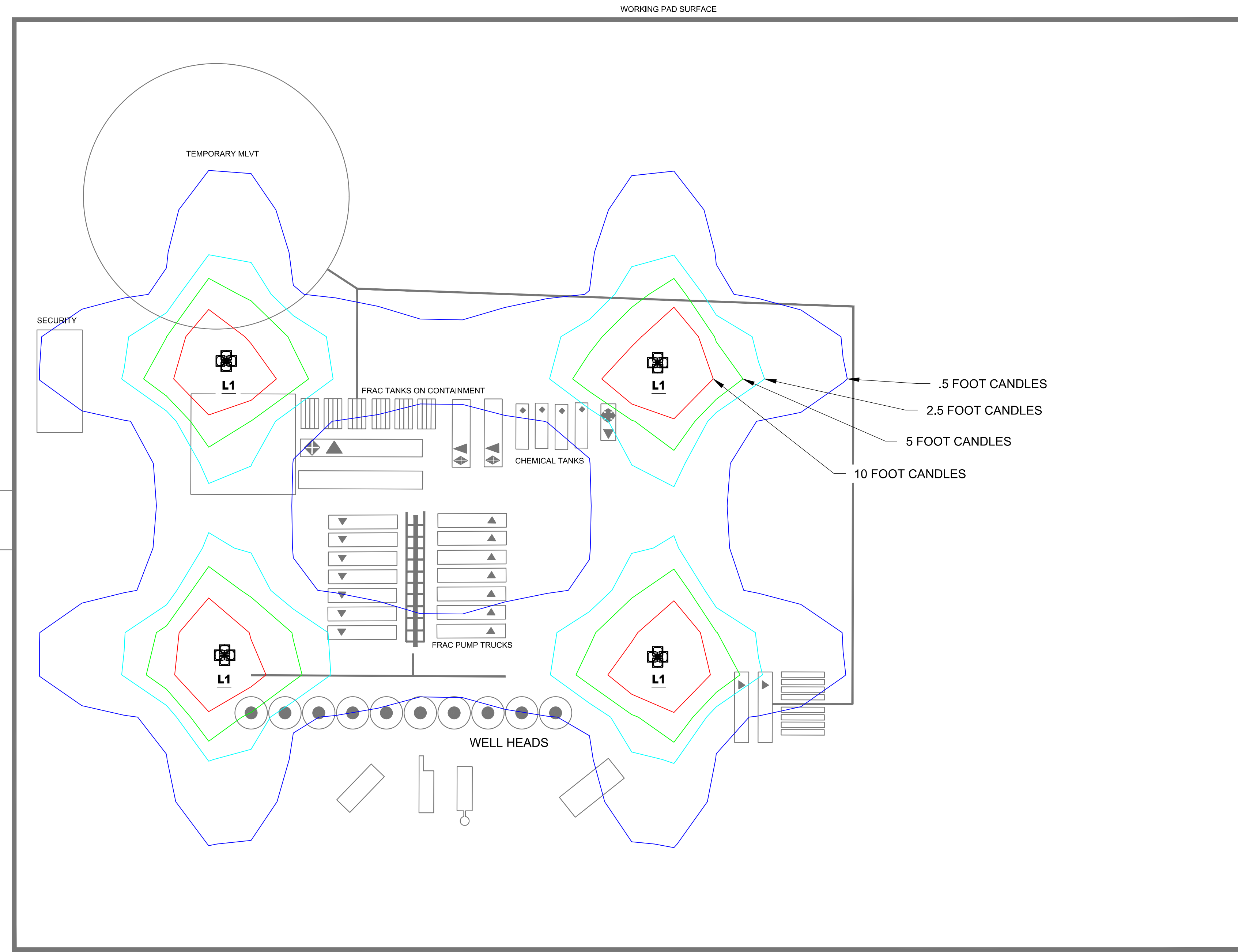

1/32"=1'-0" 0 16' 32' 64'

FILE LOCATION: G:\DIS_CLIENT_PROJECTS\BISON OIL & GAS\ORADO 36 PHOTOMETRICS\ELECT\DRAWINGS\DP-ELE-7502.DWG LAST SAVED: 08/21/24 BY: Reed, Aaron PLOT TIME/DATE: August 21, 2024

- NOTES:
- ALL LIGHT FIXTURES AND INSTALLATION MATERIALS SHALL BE IN ACCORDANCE WITH THE LATEST ISSUE OF LOCAL AND NATIONAL ELECTRICAL CODES, ELECTRICAL SPECIFICATIONS AND DRAWINGS.
 - PRODUCTION FACILITY SHALL BE SIMULTANEOUSLY CONSTRUCTED. PERMANENT PRODUCTION FACILITY LIGHTING SHALL NOT BE IN USE DURING DRILLING AND IS NOT TAKEN INTO ACCOUNT IN THESE CALCULATIONS. SEE DRAWING DP-ELE-7504 FOR PRODUCTION LIGHTING LAYOUT.
 - CONSTRUCTION TO FINALIZE LIGHTING LOCATIONS, NOT TO EXCEED 12 LUMENS PER SQUARE FOOT OF HARDSCAPE OVER TOTAL WORKING PAD SURFACE.
 - RIG LIGHTING WILL VARY DEPENDING ON PARTICULAR WELL BEING DRILLED.
 - DURING DRILLING, COMPLETIONS, AND FLOWBACK SITE IS USING LZ-0 STANDARDS.
 - THIS DRAWING IS BASED ON A TYPICAL DRILLING RIG AND IS SUBJECT TO VARIATIONS IN DESIGN AND LAYOUT. ANY VARIATION OF LAYOUT SHALL NOT EXCEED THE FIXTURE COUNTS LISTED ON THIS DRAWING.



REVISIONS					
REV	DESCRIPTION	DATE	DWN	CHK	APP
△					
△					
△					
△					
△					
△	ISSUED FOR CONSTRUCTION	08/21/24	ACR	RJS	RDH

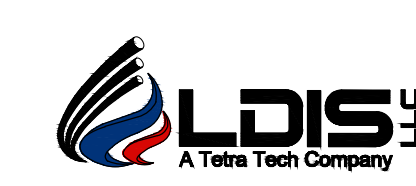

BISON OPERATIONS
DORADO 36 PHOTOMETRICS
ELECTRICAL
LIGHTING - WELL COMPLETION

DRAWN BY: ACR	08/14/24	REVIEWED BY: RJS	SCALE: 1/32"=1'-0"
CHECKED BY: RJS		APPROVED BY: RDH	DRAWING NUMBER DP-ELE-7502

THIS DRAWING AND THE DESIGN IT COVERS ARE CONFIDENTIAL AND REMAIN THE PROPERTY OF BISON IV OPERATING AND SHALL NOT BE DISCLOSED TO OTHERS OR REPRODUCED IN ANY MANNER OR USED FOR ANY PURPOSE WHATSOEVER EXCEPT BY WRITTEN PERMISSION BY THE OWNER.

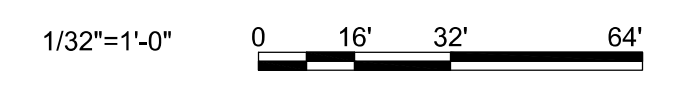
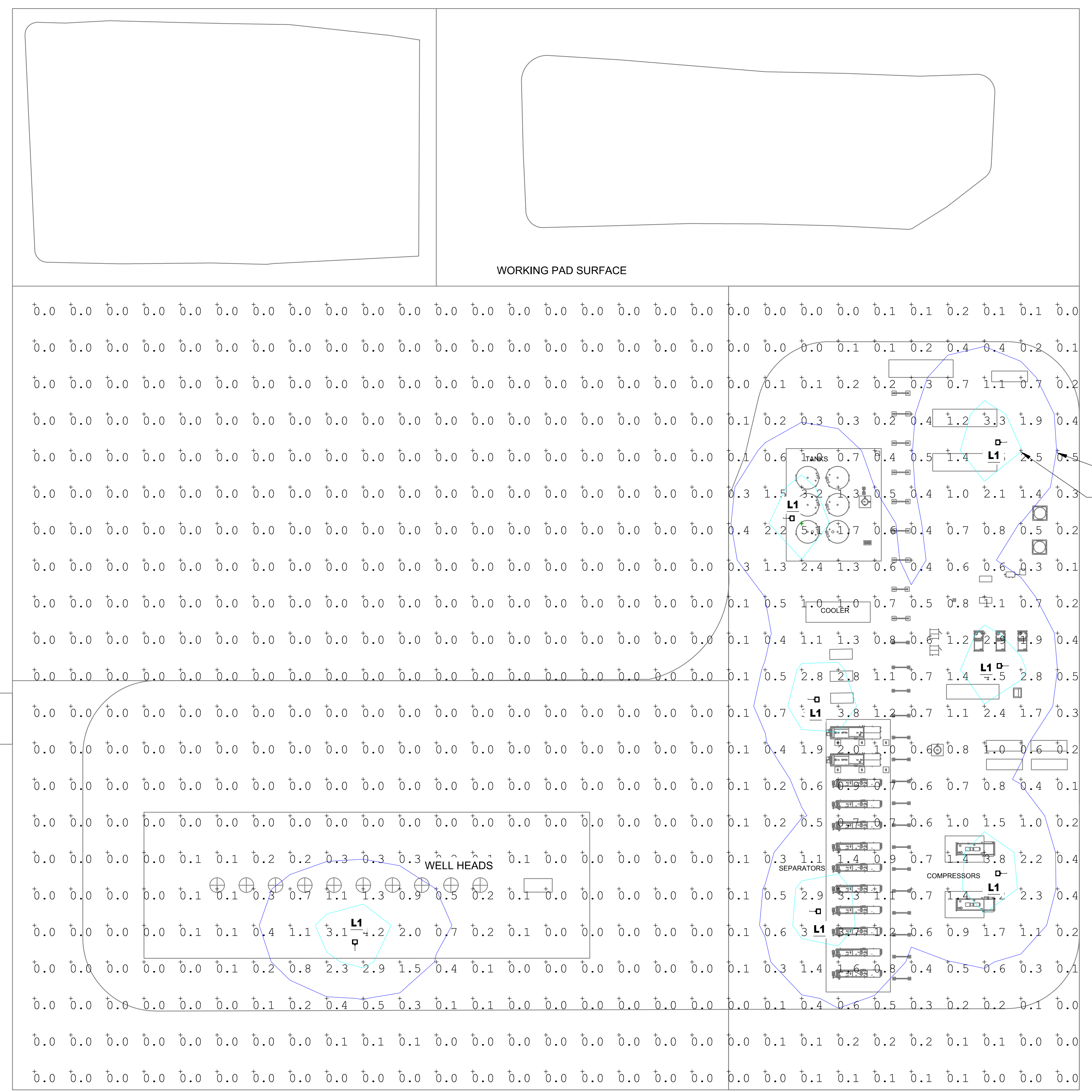
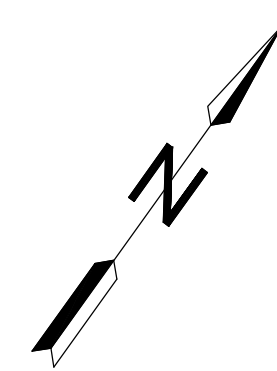

NOTES:
 1. THIS DRAWING IS INTENDED TO SHOW FOOTCANDLE POINT CALCULATING FOR THIS PHASE OF SITE DEVELOPMENT. REFER TO DRAWING DP-ELE-7504 FOR FURTHER LIGHTING DETAILS.
 2. CONSTRUCTION TO FINALIZE LIGHTING LOCATIONS, NOT TO EXCEED 0.5 LUMENS PER SQUARE FOOT OF HARDSCAPE OVER TOTAL WORKING PAD SURFACE.



REVISIONS						
REV	DESCRIPTION	DATE	DWN	CHK	APP	
△						
△						
△						
△						
△	ISSUED FOR CONSTRUCTION	08/21/24	ACR	RJS	RDH	



BISON OPERATIONS
 DORADO 36 PHOTOMETRICS
 ELECTRICAL
 LIGHTING CALCULATIONS - PRODUCTION

DRAWN BY: ACR	08/13/24	REVIEWED BY: RJS	SCALE: 1/32"=1'-0"
CHECKED BY: RJS		APPROVED BY: RDH	DRAWING NUMBER DP-ELE-7505

FILE LOCATION: G:\VDS_CLIENT_PROJECTS\BISON OIL & GAS\DORADO 36 PHOTOMETRICS\ELECT\DRAWINGS\DP-ELE-7505.DWG LAST SAVED: 08/20/24 BY: Reed, Aaron PLOT TIME/DATE: August 21, 2024



THE INFORMATION CONTAINED HEREIN SHALL BE CONSIDERED THE SOLE PROPERTY OF JCA COMPANIES, JCA RENTALS, LLC/C&M OILFIELD RENTALS, LLC/C-MOR ENERGY SERVICES, LLC AND RECIPIENT THEREOF AGREES NOT TO DISCLOSE SAID INFORMATION TO PARTIES OUTSIDE THE RECIPIENTS ORGANIZATION AND TO USE, MODIFY, CHANGE OR DUPLICATE SAID INFORMATION FOR ANY PURPOSES EXCEPT AS SPECIFIED BY JCA RENTALS, LLC/C&M OILFIELD RENTALS, LLC/C-MOR ENERGY SERVICES, LLC WITH THE WRITTEN PERMISSION OF JCA COMPANIES, JCA RENTALS, LLC/C&M OILFIELD RENTALS, LLC/C-MOR ENERGY SERVICES, LLC.

TECHNICAL INFORMATION SHEET FOR CROWN JEWEL LIGHT SYSTEM

INTENDED USE

The C-MOR Crown Jewel system is designed to be installed on the crown handrails of most drilling rigs

SPECIFICATIONS:

- Designed to mount to undamaged guardrails which meet OSHA 1910.29(b)(1)
- Engineered mount system (RADesign 1085035) meets API 4F 4th Edition land-based wind loads (180' @ 90 mph)
- 600 W LED instant start lights
- Dropped object report RADTM-18-1001-01
- Light and junction box retention nets: Dropsafe 7500185
- Rig light safety cables: Kennedy 250 LBS WLL
- Mount system weight: 21 lbs/ light
- Light and bracket assembly weight: 32 lbs/ light
- Junction box weight: 33 lbs/ rig
- Appleton Locking connectors + cable 3.2 lbs/ light
- Complete individual light/mount/cable weight 57 lbs.
- Typical 8 light Crown Jewel full installation: 489 lbs

ENGINE SYSTEM

- Mitsubishi® L3E
- Diesel fueled
- EPA Final Tier 4
- 3 cylinder
- 0.95 L displacement
- Liquid cooled
- Power @ 1,800 rpm – HP (kW):
 - Standby: 12.2 (9.1)
 - Prime: 10.5 (7.8)

Fuel System

- Polyethylene tank – 39.9 gal (151.04 L) capacity
- Run time – hr:
 - Lights only: 117*
 - 100% load: 60*
- Fuel consumption – gal/hr (L/hr):
 - Lights only: 0.34 (1.29)*
 - 100% load: 0.67 (2.54)*
- Exterior fill port diameter: 3.5 in (89 mm)

Cooling System

- Air filter: Dry type cartridge

Lubrication System

- Oil filter: Full flow, spin-on type
- 750-hr service interval**

**Data based on engine manufacturer and field test data after 100-hr engine break-in period. Actual results may vary, according to factors such as age and maintenance of equipment, environmental conditions, and fuel density. For fuel and maintenance recommendations, see owner's manual.*

***For maximum service interval, replace oil filter after 50-hr break-in period. For oil filter model number, see owner's manual.*

GENERATOR

- 60 Hz engine/generator
- Marathon Electric® brushless
- Up to 6 kW output
- 120/240 VAC, 20/30 A
- ± 6% capacitor voltage regulation

CONTROLS

- External, illuminated control panel with sealed switches
- 4-position key activated switch (off, run, glow, start)
- Digital hour meter
- Automatic shutdown for low oil pressure and high coolant temperature
- One switch controls all light fixtures
- Wet-stacking mitigation



FLOODLIGHTS

- Four 296 W LED fixtures
- Aluminum and polymer housing
- Efficiency: 145 LPW
- Lm/fixture: 43,050
- Total lm: 172,200
- Coverage: 19,526 ft² (1,814 m²) @ 0.5 ft-c
- IP68 LED modules; IP65 rated drivers
- Fixture-mounted drivers

ELECTRICAL SYSTEM

- 30 A start trip breaker (ensures no-load condition exists at start-up)
- Floodlight circuits with sealed 10 A breakers
- Convenience receptacles with individual breakers:
 - One 120 VAC, 20 A, GFCI, duplex outlet (NEMA 5-20R type)
 - One 240 VAC, 30 A, twistlock outlet (NEMA L6-30R type)
- Wiring is sized and fused to required amperage draw
- 440 CCA wet cell battery

MAST

- Vertical operation and storage
- Maximum height: 23 ft (7 m)
- Five sections with polymer guides
- Ground-adjustable light fixtures
- Winch: Dual handle, manual crank
- Distinctive angled fixture mount for common light distribution
- Rotation: 359° range of motion, adjustable from ground during full extension
- Industrial black powder-coat finish
- Self-retracting, coiled mast cord

ENCLOSURE

- Hood:
 - Injection-molded with UV protected colorant
 - Flip-up design for ease of service
- Sound rating: 63 dB(A) at 23 ft (7 m) @ prime power
- Lifting point and fork pockets
- Multi-lingual operating and safety decals
- Illuminated license plate holder
- Document holder with owner's manual – includes AC and DC wiring diagrams

TRAILER

- Tubular steel frame
- 2 in (50.8 mm) ball hitch
- Three 1,200 lb (544 kg) tube-and-sleeve leveling jacks – lockable into stowed positions
- 7,800 lb (3,538 kg) safety chains with spring loaded safety hooks
- DOT approved LED lights: Tail, side, brake, and directionals
- 2,200 lb (998 kg) leaf spring axle
- Molded polyethylene fenders
- Tires: ST175/80D13, 6 ply
- Track width: 47 in (119.4 cm)

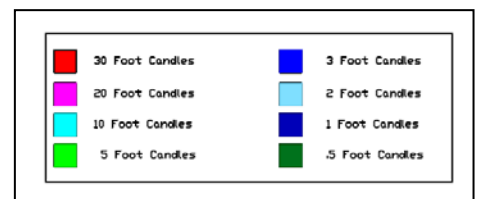
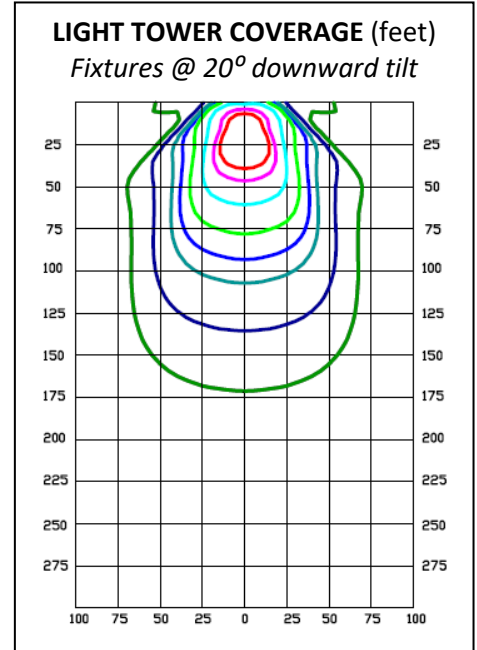

OPTIONS

- Electric winch
- Winch cover
- Positive air shutdown
- Tandem tow
- Battery charger
- Battery disconnect
- PowerZone® controller
- Telemetry
- Lower radiator hose heater
- Fuel filter heater

DIMENSIONS

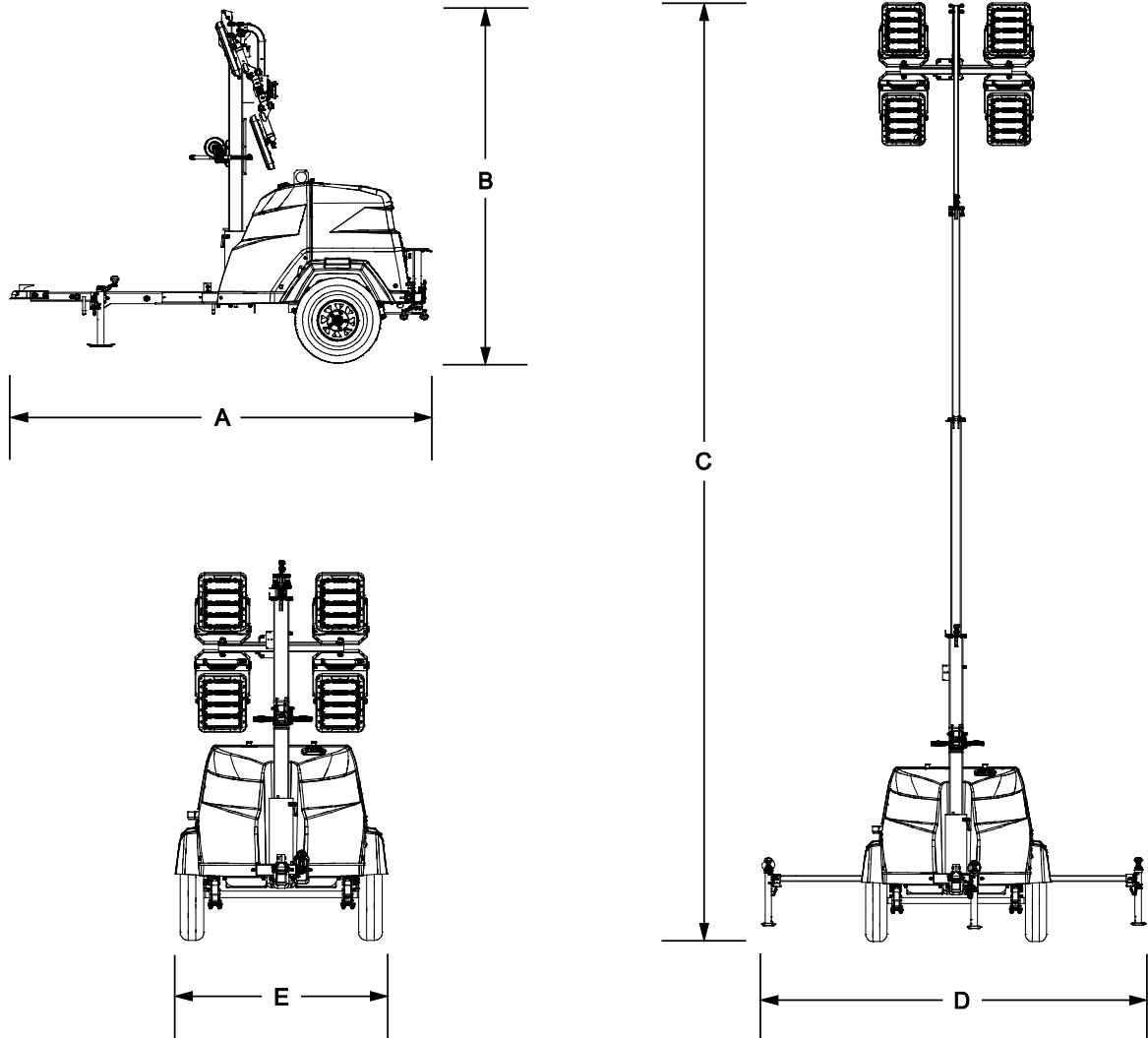

A	B	C	D	E
118 in (3 m)	101 in (2.6 m)	23 ft (7 m)	10 ft (3.05 m)	57 in (1.45 m)

WEIGHT

- Dry: 1,310 lb (594 kg)
- Operating: 1,600 lb (726 kg)

AMBIENT CLIMATE RATINGS

- Maximum wind speed: 65 mph (105 kph)
- Maximum air temperature – °F (°C):
 - Lights only: 120 (49)
 - 100% load: 104 (40)

WARRANTY

- Tower: 1 year, unlimited hours/2 years, 2,000 hours
- LED modules and drivers: 5 year limited warranty

CERTIFICATIONS

CSA approved, listed

FOR MORE INFORMATION

Owner's manual is available at www.generacmobileproducts.com/resources-tools/manuals.

LAS45S-T4.ies

COOPER LIGHTING SOLUTIONS - LUMARK (FORMERLY EATON)

LAS45S-T4

AREA SITE SMALL HOUSING, TYPE IV

Single (Arm)

Luminaire Watts	153	W
Ballast/Driver Factor	1.00	
Light Loss Factor	1.00	
Total Proration Factor	1.00	
Luminaire Lumens	19720	lms

 25 ft

Min: 0.50 fc ✕
Max/Avg: 3.6

Avg: 1.6 fc
Avg/Min: 3.2

Max: 5.7 fc +
Max/Min: 11

Project		Catalog #		Type	
Prepared by		Notes		Date	



Lumark

LAS

Area / Site Luminaire

Product Features



Product Certifications



Interactive Menu

- Stock Ordering Information page 2
- Ordering Information page 2
- Product Specifications page 2
- Mounting Details page 3
- Energy and Performance Data page 3
- Controls Options page 4

Quick Facts

- 10-position lumen selectable across 2 housing sizes
- Lumen packages range from 4,900 - 34,000 lumens (30W - 250W)
- Replaces up to 450W and 1,000W HID equivalent
- Efficacies up to 135 lumens per watt at maximum output
- Energy and maintenance savings up to 79% versus HID solutions

Dimensional Details

LAS45 - Pole Mount

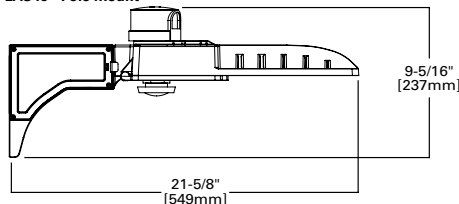

LAS45

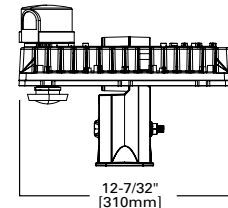
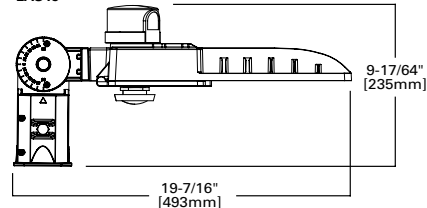

LAS100 - Pole Mount

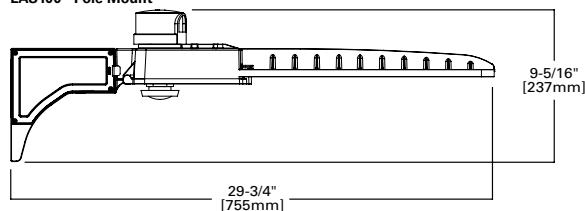

LAS100

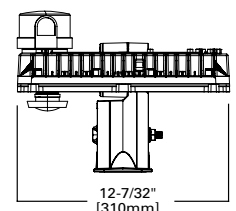
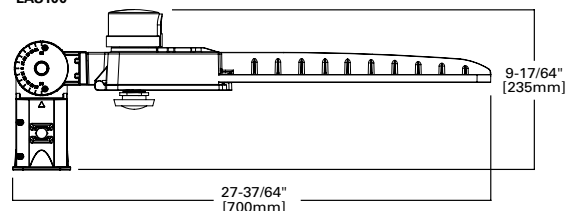

Stock Ordering Information

SAMPLE NUMBER: **LAS45S-T4**

Model Number ¹		Distribution	Voltage
LAS45P=Pole Mount Arm, 450W HID Equivalent LAS45S=Slipfitter Mount, 450W HID Equivalent	LAS100P=Pole Mont Arm, 1,000W HID Equivalent LAS100S=Slipfitter Mount, 1,000W HID Equivalent	T3=Type III T4=Type IV T5=Type V	[Blank]=Universal, 120-277V HV=High Voltage, 347-480V ²
NOTES: 1. DesignLights Consortium® Qualified. Refer to www.designlights.org Qualified Products List under Family Models for details. 2. Supplied with shoring cap. Use NEMA 3-PIN twistlock photocontrol that matches the input voltage used (either 347V or 480V) as desired.			

Ordering Information

SAMPLE NUMBER: **LAS45S-T4-MS/DIM-L40W**

Model Number ^{1,2}	Distribution	Voltage	Options	Accessories (Order Separately)
LAS45P=Pole Mount Arm, 450W HID Equivalent LAS45S=Slipfitter Mount, 450W HID Equivalent LAS100P=Pole Mount Arm, 1,000W HID Equivalent LAS100S=Slipfitter Mount, 1,000W HID Equivalent	T3=Type III T4=Type IV T5=Type V	[Blank]=Universal, 120-277V HV=High Voltage, 347-480V ³	MS/DIM-L40W=Motion Sensor for Dimming Operation, 21' - 40' Mounting Height	FSIR-100=Wireless Configuration Tool for Motion Sensor ⁴ RABBZ=Wall Mount Tenon Adapter RABX-BZ=Pole Mount Tenon Adapter
NOTES: 1. DesignLights Consortium® Qualified. Refer to www.designlights.org Qualified Products List under Family Models for details. 2. Standard lead times apply. Sensor versions do not include lumen select switch. Max light output can be field-programmed via the motion sensor with the accessory configuration tool. 3. Supplied with shoring cap. Use NEMA 3-PIN twistlock receptacle photocontrol that matches the input voltage used (either 347V or 480V) as desired. 4. This tool enables adjustment to Motion Sensor (MS) parameters including high and low modes, sensitivity, time delay, cutoff and more. Consult your lighting representative for more information.				

Product Specifications

Construction

- Die-cast aluminum housing with hinged, die-cast aluminum door
- Pole mount arm mounts directly to minimum 4 inch round or square poles (recommended Type N drill pattern)
- Slipfitter mounts 2-3/8" vertical or horizontal tenons; Downward facing only
- IP65 rated housing enclosure
- 10-position lumen select switch accessible via hinged housing door

Optics

- UV-resistant polycarbonate optics
- Full cutoff when mounted at 0 degrees tilt
- 4000K CCT, 70CRI minimum standard
- IP66 optical enclosures

Electrical

- 40°C minimum operating temperature
- 40°C maximum operating temperature
- >0.9 power factor
- <20% total harmonic distortion
- Class P drivers incorporate internal MOVs designed to withstand 6kV of surge
- 0-10V dimming driver is standard
- 3-PIN NEMA twistlock photocontrol receptacle and photocontrol included (UNV configurations)

Finish

- Standard color is bronze
- Finish only warrantied for a period of 1 year

Shipping Data

- LAS45S / LAS45P: 14.0 lbs. (6.4 kgs.)
- LAS100SS / LAS100P: 18.0 lbs. (8.2 kgs.)

Mounting Details

Mounting Configurations and EPAs

Housing Size	Mounting	Tilt							
			1	2 @ 90°	2 @ 120°	2 @ 180°	3 @ 90°	3 @ 120°	4 @ 90°
LAS45	Slipfitter	0°	0.488	0.772	1.110	0.973	1.258	1.320	1.262
LAS45	Slipfitter	10°	0.488	0.854	1.217	0.975	1.305	1.532	1.307
LAS45	Slipfitter	20°	0.488	1.158	1.440	0.977	1.644	2.102	1.646
LAS45	Slipfitter	30°	0.488	1.413	1.661	0.972	1.892	2.582	1.896
LAS45	Slipfitter	45°	0.488	1.733	1.972	0.974	2.220	3.208	2.224
LAS45	Pole Mount	N/A	0.560	0.930	1.090	1.120	1.400	1.440	1.460
LAS100	Slipfitter	0°	0.604	0.888	1.237	1.208	1.489	1.521	1.492
LAS100	Slipfitter	10°	0.604	1.171	1.541	1.204	1.765	2.100	1.765
LAS100	Slipfitter	20°	0.604	1.597	1.920	1.202	2.191	2.908	2.195
LAS100	Slipfitter	30°	0.603	1.996	2.290	1.204	2.591	3.670	2.595
LAS100	Slipfitter	45°	0.603	2.478	2.776	1.201	3.070	4.651	4.375
LAS100	Pole Mount	N/A	0.670	1.030	1.250	1.340	1.610	1.610	1.660

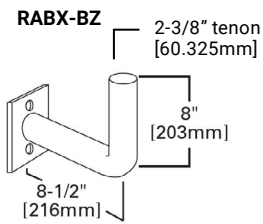
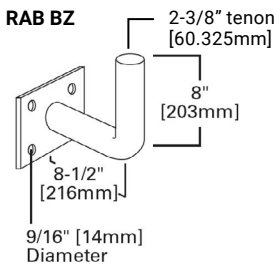

Pole Mount Arm

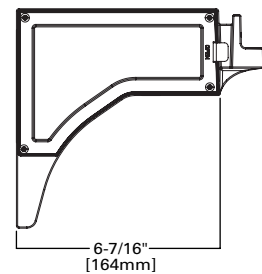
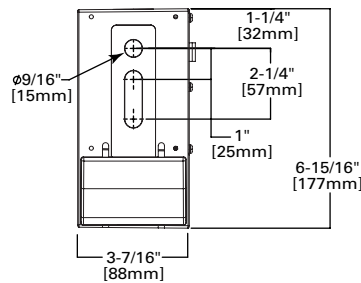

Round Pole Mount

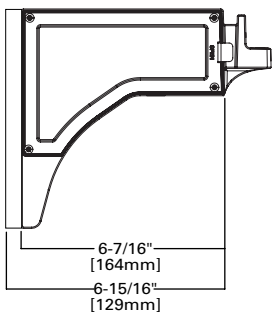

Type "N" Drill Pattern

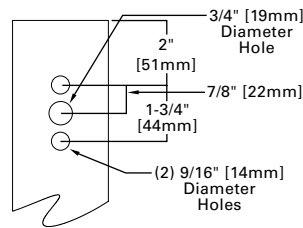

Energy and Performance Data

Lumen Maintenance

Ambient Temperature	TM-21 Lumen Maintenance (54,000 Hours)	Theoretical L70 (Hours)
Up to 40°C	85.80%	126,000

Energy and Performance Data (cont.)

[View LAS IES files](#)

Power and Lumens (LAS45)

Lumen Select Switch	Position 0 (Factory Preset)	1	2	3	4	5	6	7	8	9	
Power (Watts)	152.7	135.4	119.7	99.2	89.5	79.2	75.2	68.8	29.3	29.3	
Input Current @ 120V (A)	1.27	1.13	1.00	0.83	0.75	0.66	0.63	0.57	0.27	0.27	
Input Current @ 277V (A)	0.58	0.53	0.48	0.42	0.39	0.36	0.34	0.32	0.19	0.19	
Input Current @ 347V (A)	0.45	0.40	0.36	0.30	0.27	0.24	0.23	0.21	0.10	0.10	
Input Current @ 480V (A)	0.33	0.30	0.27	0.23	0.21	0.19	0.19	0.17	0.09	0.09	
Distribution											
T3 (Type III)	Lumens	20,089	18,434	16,810	14,515	13,360	12,083	11,550	10,705	4,901	4,901
	BUG Rating ¹	B3-U0-G3	B3-U0-G3	B3-U0-G3	B3-U0-G3	B3-U0-G3	B3-U0-G3	B3-U0-G3	B2-U0-G2	B1-U0-G1	B1-U0-G1
	Lumens per Watt	132	136	140	146	149	153	154	156	167	167
T4 (Type IV)	Lumens	19,720	18,095	16,502	14,249	13,115	11,862	11,338	10,509	4,811	4,811
	BUG Rating ¹	B3-U0-G3	B3-U0-G3	B3-U0-G3	B3-U0-G3	B3-U0-G3	B2-U0-G3	B2-U0-G3	B2-U0-G3	B1-U0-G2	B1-U0-G2
	Lumens per Watt	129	134	138	144	147	150	151	153	164	164
T5 (Type V)	Lumens	19,956	18,311	16,698	14,418	13,271	12,003	11,473	10,634	4,868	4,868
	BUG Rating ¹	B3-U0-G3	B4-U0-G2	B4-U0-G2	B3-U0-G2	B3-U0-G2	B3-U0-G2	B3-U0-G1	B3-U0-G1	B2-U0-G1	B2-U0-G1
	Lumens per Watt	131	135	139	145	148	152	153	155	166	166
NOTES:											
1. All BUG Ratings reported with fixture oriented at 0 degrees.											

Power and Lumens (LAS100)

Lumen Select Switch	Position 0 (Factory Preset)	1	2	3	4	5	6	7	8	9	
Power (Watts)	251.0	222.2	196.4	162.8	146.8	129.9	123.4	112.9	48.0	48.0	
Input Current @ 120V (A)	2.09	1.86	1.64	1.36	1.23	1.09	1.03	0.95	0.41	0.41	
Input Current @ 277V (A)	0.90	0.82	0.73	0.62	0.57	0.52	0.50	0.46	0.28	0.28	
Input Current @ 347V (A)	0.74	0.66	0.59	0.49	0.44	0.40	0.38	0.34	0.15	0.15	
Input Current @ 480V (A)	0.55	0.49	0.44	0.37	0.34	0.30	0.29	0.27	0.13	0.13	
Distribution											
T3 (Type III)	Lumens	33,965	31,166	28,421	24,541	22,588	20,429	19,527	18,100	8,286	8,286
	BUG Rating ¹	B4-U0-G4	B4-U0-G4	B4-U0-G4	B3-U0-G3	B3-U0-G3	B3-U0-G3	B3-U0-G3	B3-U0-G3	B2-U0-G2	B2-U0-G2
	Lumens per Watt	135	140	145	151	154	157	158	160	173	173
T4 (Type IV)	Lumens	33,342	30,594	27,900	24,090	22,174	20,055	19,169	17,768	8,134	8,134
	BUG Rating ¹	B4-U0-G4	B3-U0-G4	B3-U0-G4	B3-U0-G4	B3-U0-G3	B3-U0-G3	B3-U0-G3	B3-U0-G3	B2-U0-G2	B2-U0-G2
	Lumens per Watt	133	138	142	148	151	154	155	157	169	169
T5 (Type V)	Lumens	33,740	30,959	28,232	24,378	22,438	20,294	19,398	17,980	8,231	8,231
	BUG Rating ¹	B5-U0-G3	B5-U0-G3	B4-U0-G2	B4-U0-G2	B4-U0-G2	B4-U0-G2	B4-U0-G2	B4-U0-G2	B3-U0-G1	B3-U0-G1
	Lumens per Watt	134	139	144	150	153	156	157	159	171	171
NOTES:											
1. All BUG Ratings reported with fixture oriented at 0 degrees.											

Control Options

Dimming Occupancy Sensor (MS)

These sensors are factory installed in the luminaire housing. When a sensor for dimming operation (/DIM) option is selected, the luminaire will dim down to approximately 50 percent power after five minutes of no activity detected. When activity is detected, the luminaire returns to full light output. These occupancy sensors include an integral photocell that can be activated or inactivated with the programming remote / configuration tool for "dusk-to-dawn" control or "daylight harvesting". Note: For MS sensors, the factory preset is OFF (Disabled). The programming remote / tool is a wireless tool that can be utilized to change the dimming level, time delay, sensitivity and other parameters. The sensor lens optimizes the coverage pattern for mounting heights from 21'-40'.

